

Product Type	Current Transformer
Amgis Part Number	CX-0500

SCHEMATIC:

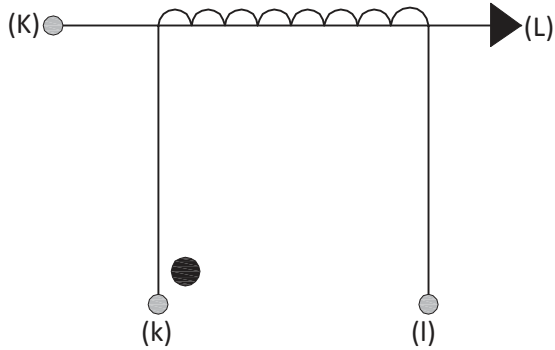

ELECTRICAL SPECIFICATION:

Rated input current	= 5Amps
Operating Frequency	= 50 / 60 Hz
Turns Ratio	= 1 : 500
DC Resistance	= 41 Ω @ 20°C
Primary to Secondary Isolation	= 2500VAC
Operating Temperature	= -40°C to +120°C
Ambient Temperature	= 60ta

MECHANICAL SPECIFICATION:

Pin Side View:

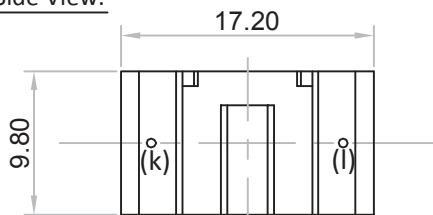

MARKING INFORMATION:

Amgis
CX-0500
Yr/Wk code

TRAFO WEIGHT:

Approx. Weight = 0.013 kg / pc

Front View:

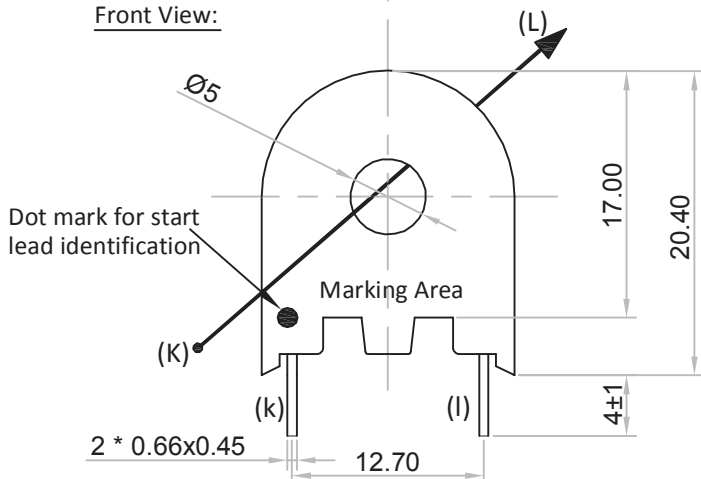

All dimensions are in mm
Linear dimensional tolerance ±0.2mm

OUTPUT RESPONSE vs INPUT CURRENT @ RATED BURDEN:

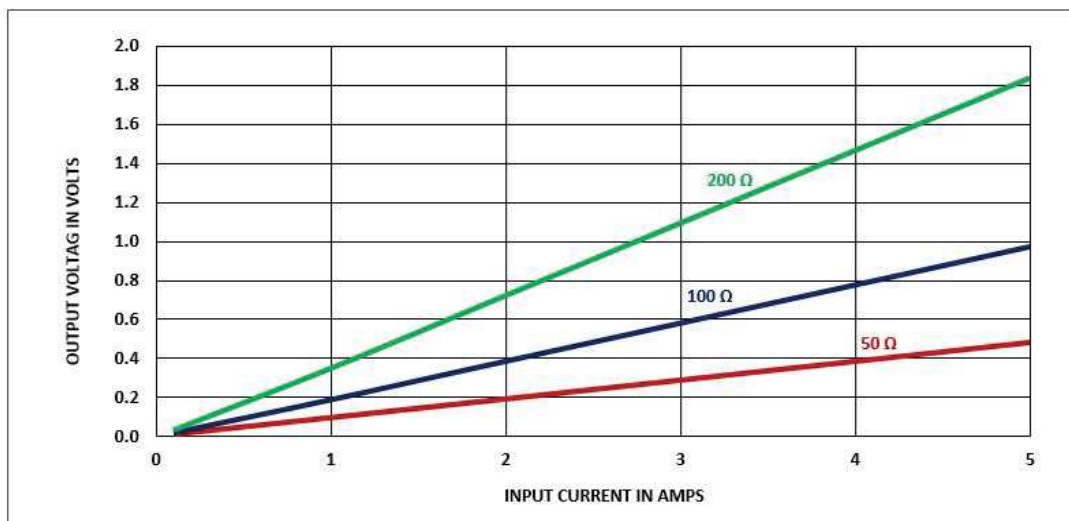

SATURATION CURRENT RESPONSE @ RATED BURDEN:

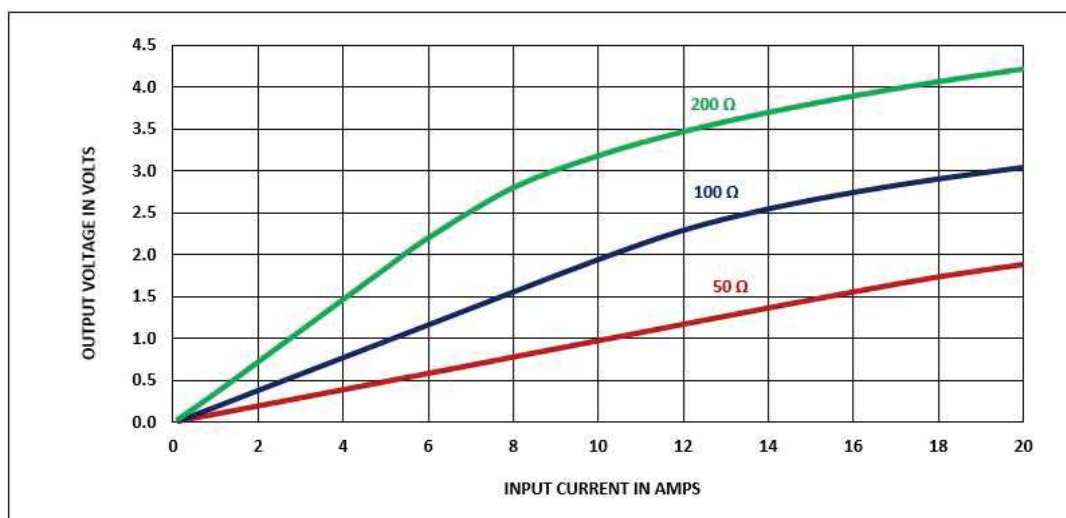

PHASE ANGLE RESPONSE vs INPUT CURRENT @ RATED BURDEN:

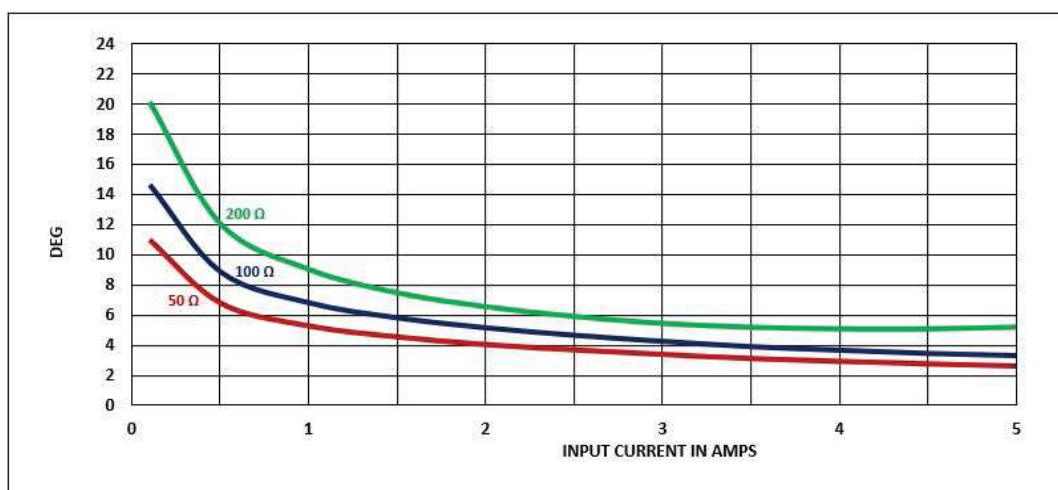

-----Initial Issue-----	1	0	K.Shanmugam	12-Nov'2015
Changes	Issue	Rev	Initial	Date